

Cuadernillo de

# Caligrafía y Trazos de las vocales

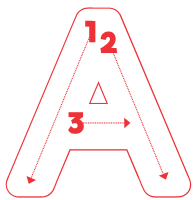

MAYÚSCULAS Y  
MINÚSCULAS

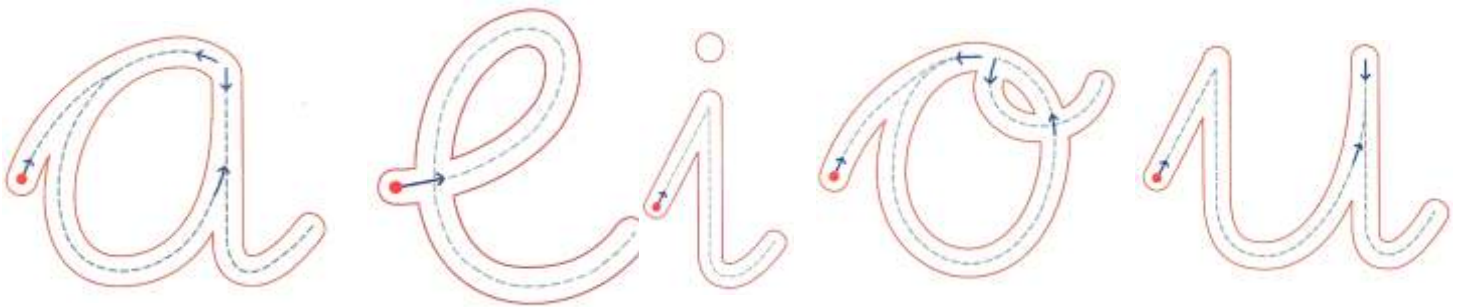
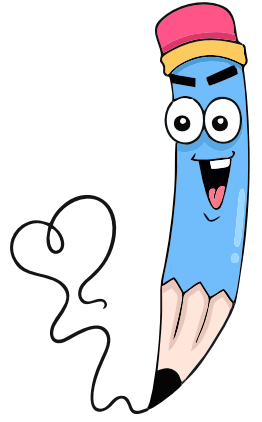
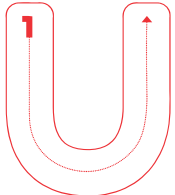
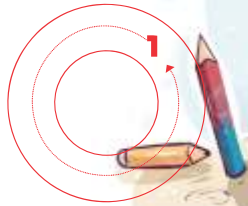
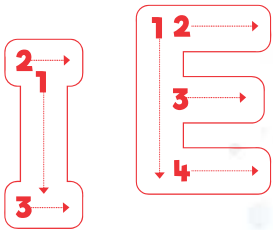

Nombre: .....

Trabajamos con la letra:

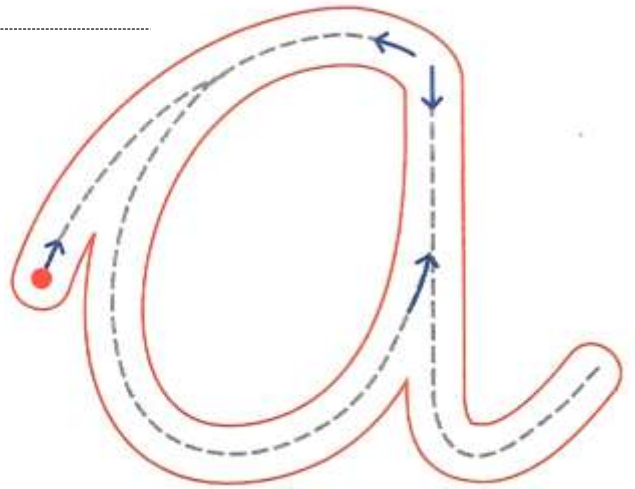

Colorea



Repasa

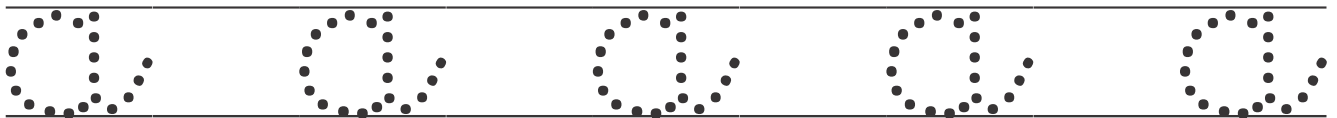
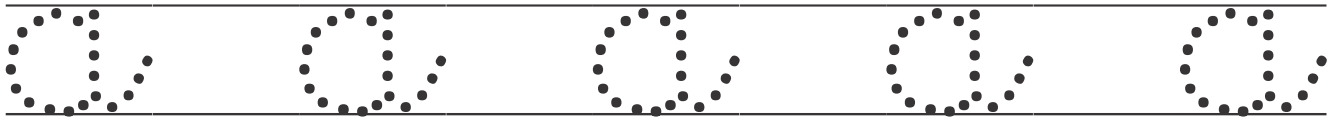

Escribe

Four sets of handwriting lines, each consisting of a solid top line, a dashed middle line, and a solid bottom line, for independent writing practice.

Nombre: .....

LETRA MAYÚSCULA

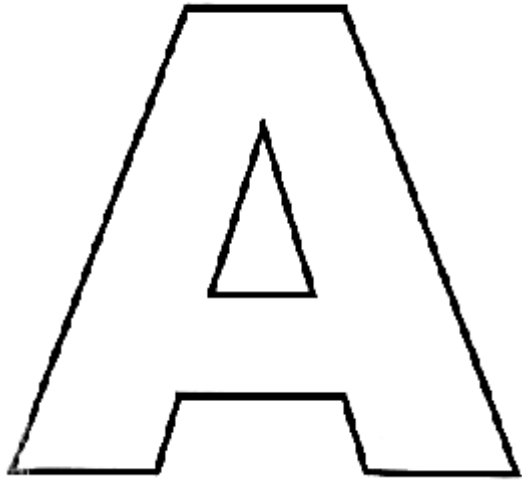

LETRA MINÚSCULA

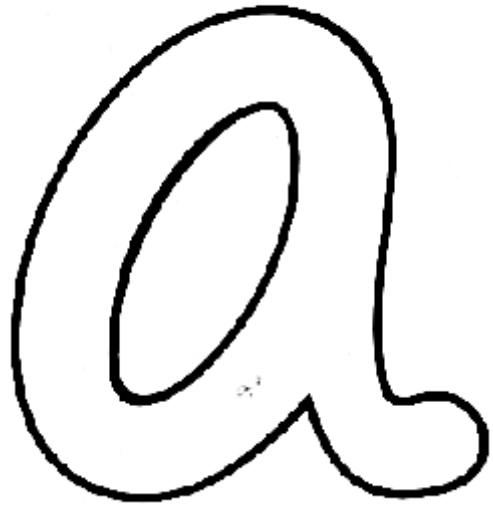

*colorea*



Repasa las  
Lineas  
Punteadas

*Ardilla*





Nombre: \_\_\_\_\_

material gratuito

Trazar las letras:

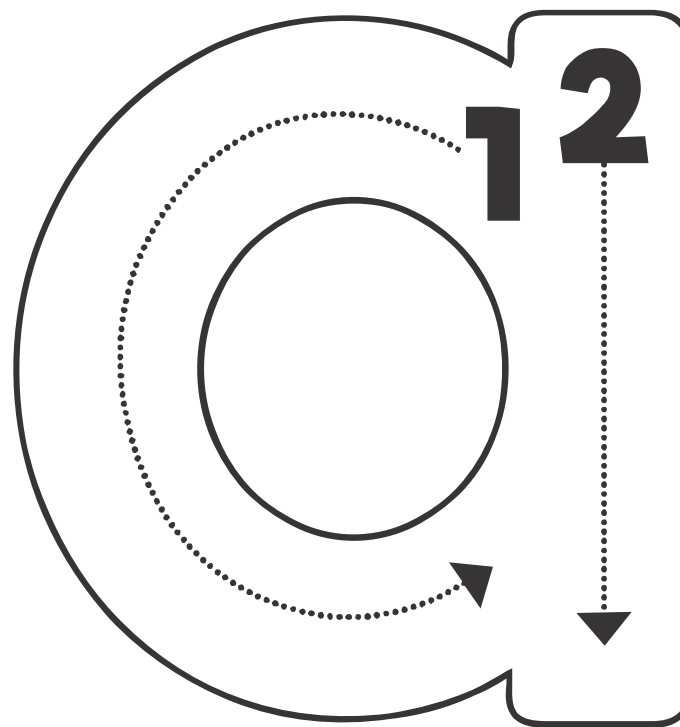
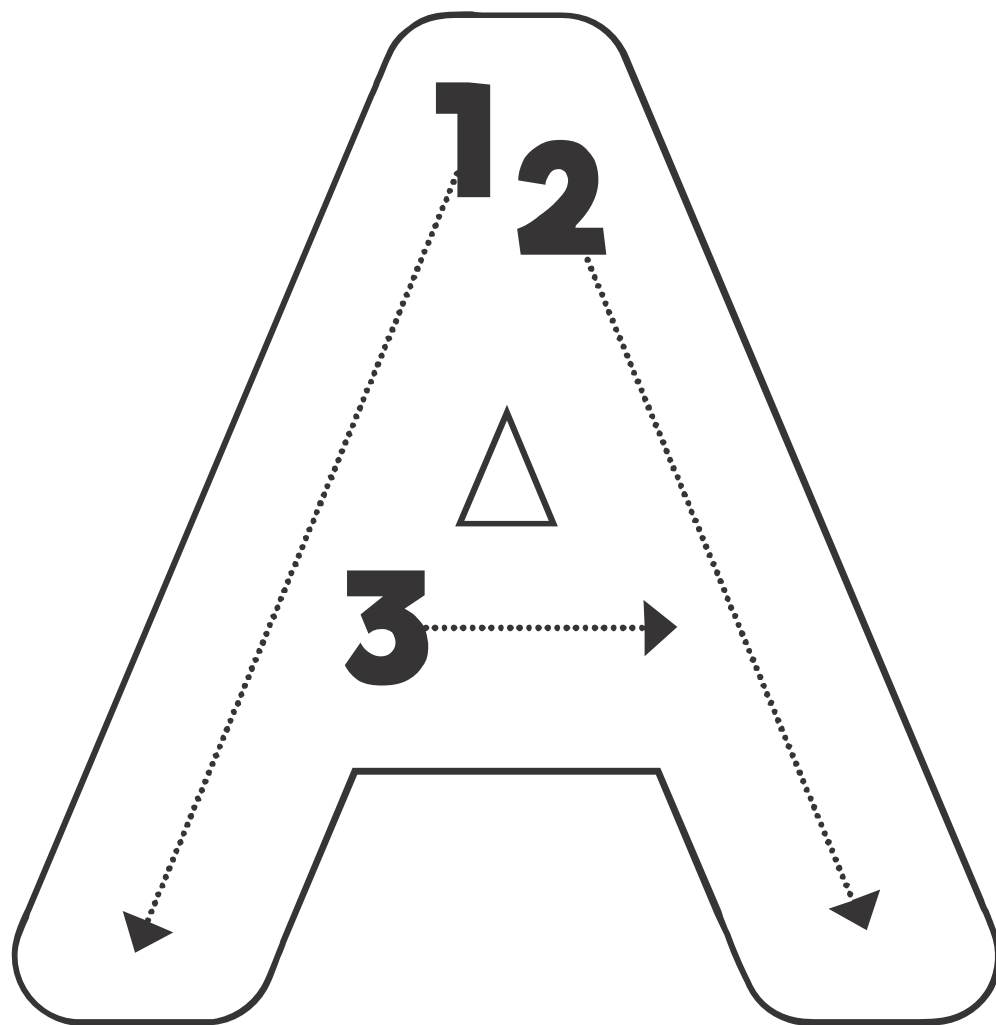

# LA LETRA A

COLOREA LA LETRA A. LUEGO COMPLETA CON ESTA LETRA LOS ESPACIOS EN BLANCO DE LAS PALABRAS.  
¿PUEDES LEER LAS PALABRAS QUE SE FORMARON?

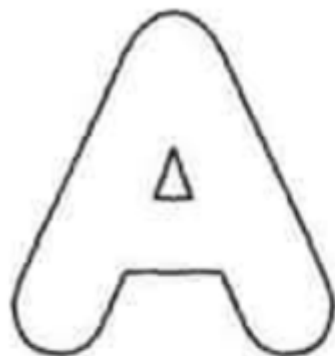

\_UTO

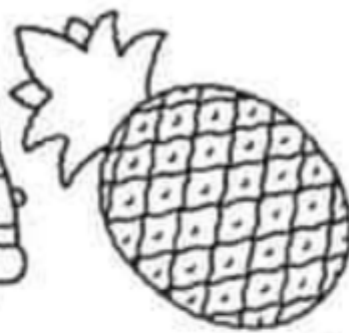

\_N\_N'



\_NCL\_



\_R\_Ñ\_



\_GUJ\_



M\_NZ\_N\_



\_RBOL



R\_N\_



C\_MP\_N\_



C\_N\_ST\_



\_BEJ\_



L\_N\_



\_VIÓN



C\_S\_

Nombre: .....

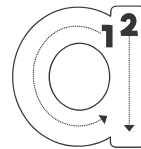
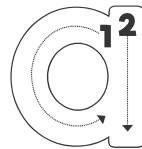
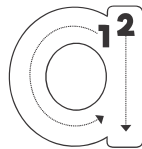
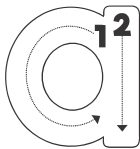
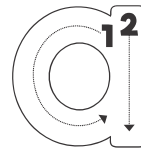
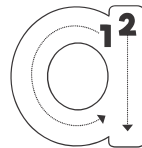
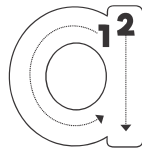
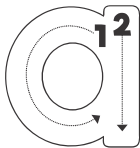
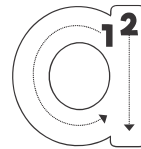
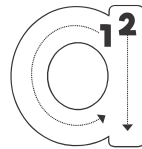
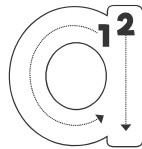
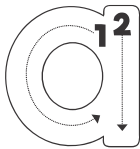
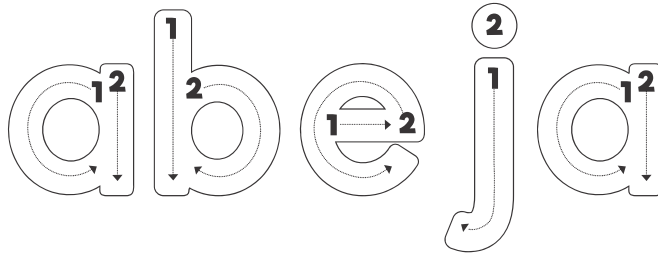
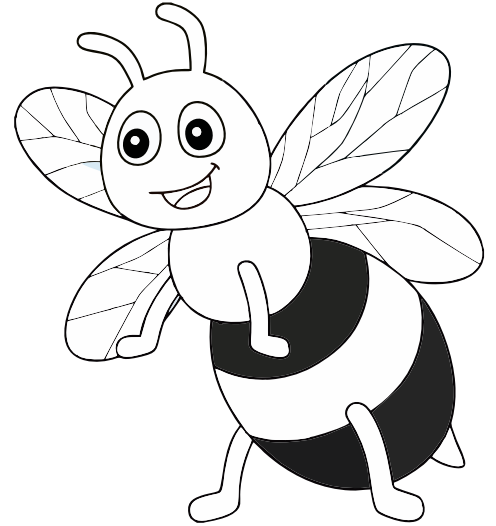
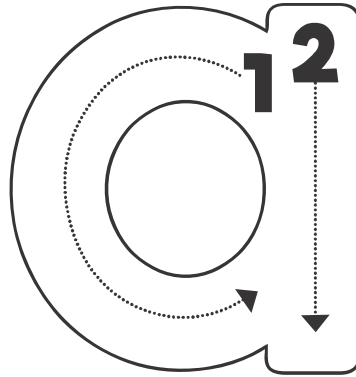
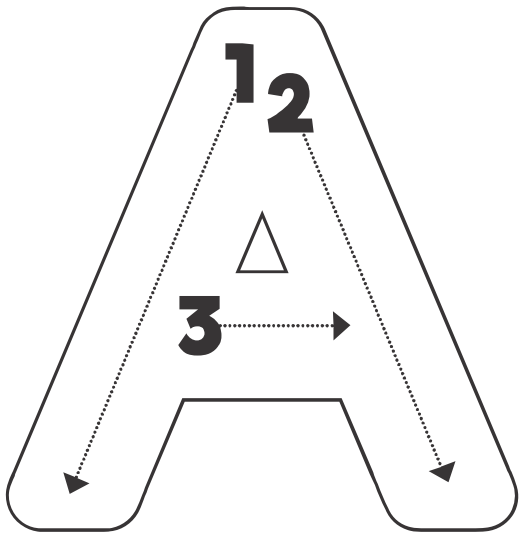



Nombre: .....

Trabajamos con la letra:

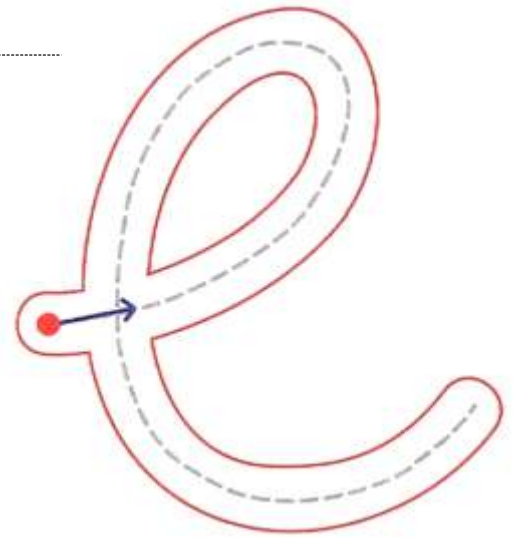

Colorea



Repasa

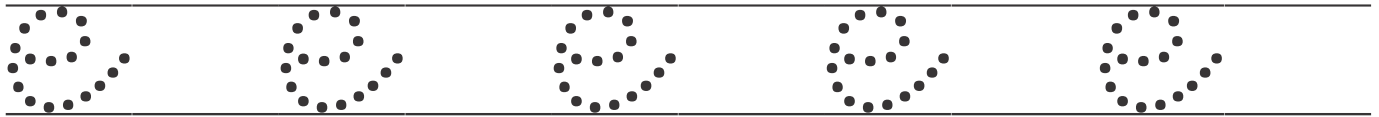

Escribe

Blank handwriting lines for independent practice, consisting of four sets of a solid top line, a dashed middle line, and a solid bottom line.

Nombre: .....

LETRA MAYÚSCULA

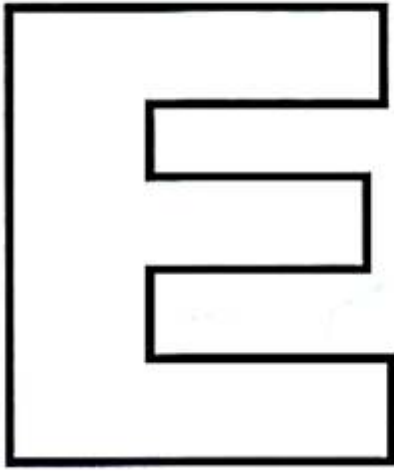

LETRA MINÚSCULA

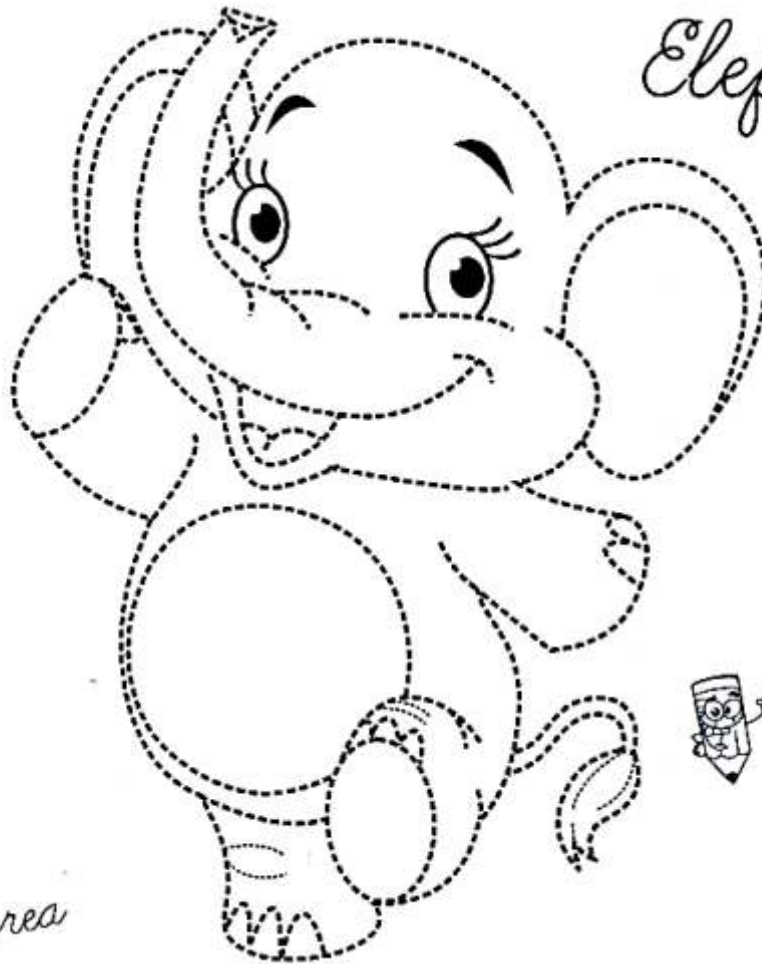
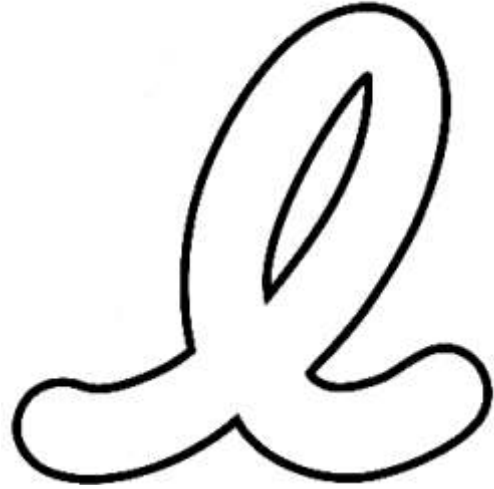

*Elefante*

*colorea*



Repasa las  
líneas  
punteadas





Nombre: \_\_\_\_\_

material gratuito

Trazar las letras:

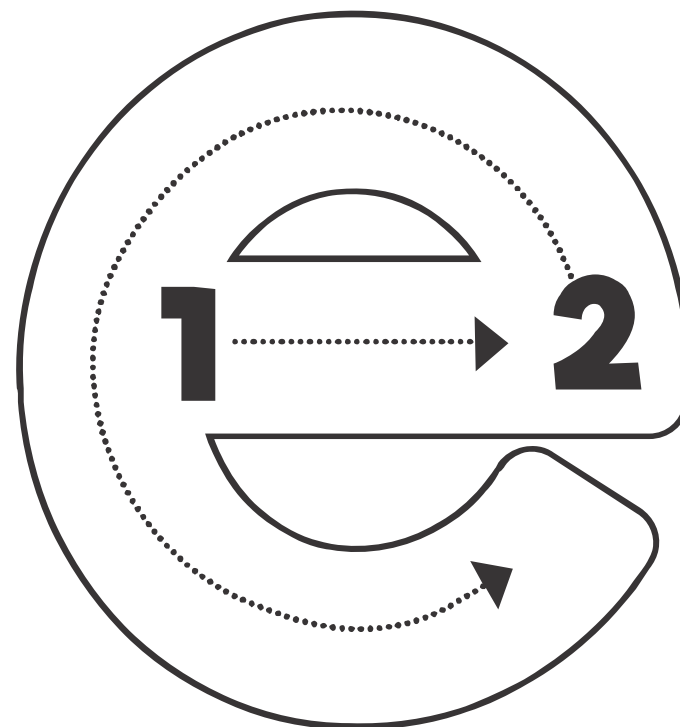
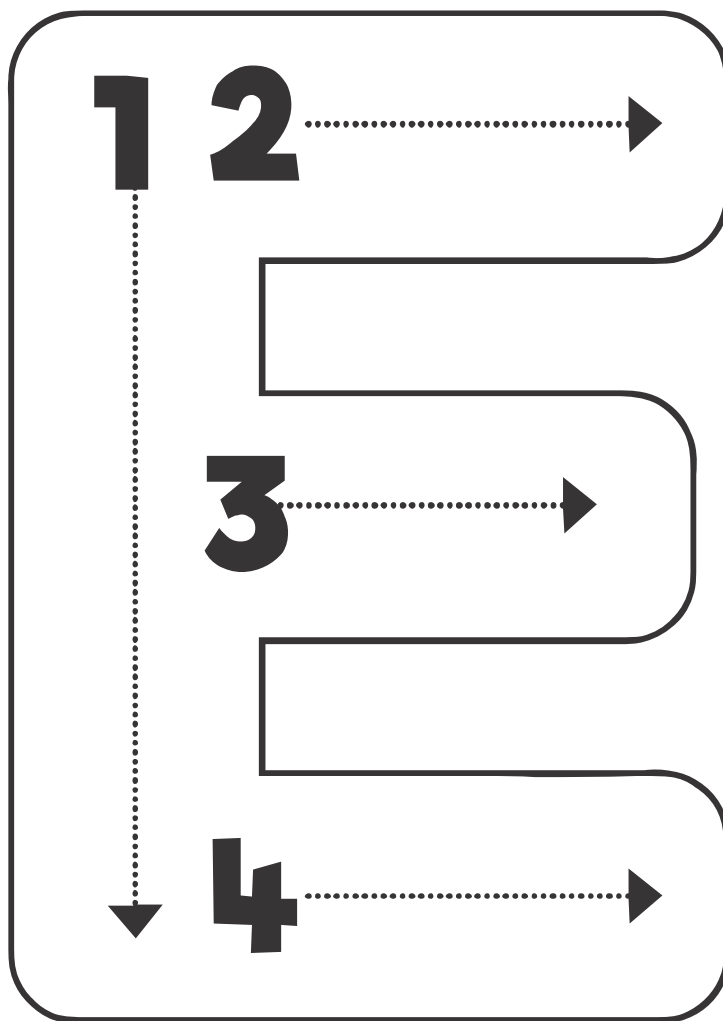

# LA LETRA E

COLOREA LA LETRA E. LUEGO COMPLETA CON ESTA LETRA LOS ESPACIOS EN BLANCO DE LAS PALABRAS.  
¿PUEDES LEER LAS PALABRAS QUE SE FORMARON!



\_MPANADA



\_STR\_LLA

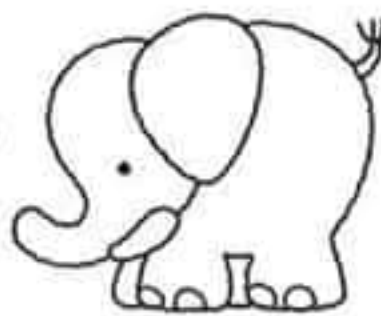

\_L\_FANT\_



R\_LOJ



\_SCOBA



V\_L\_RO



\_SCAL\_RA

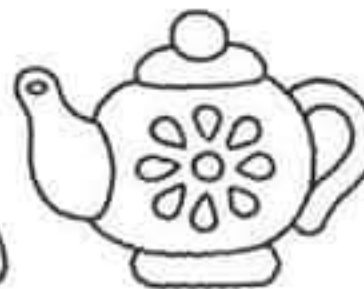

T\_T\_RA



P\_Z

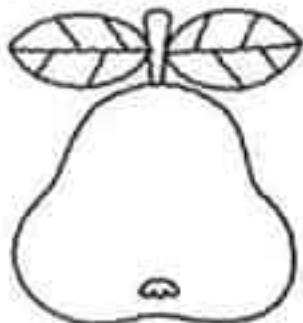

P\_RA



R\_GAD\_RA



\_SP\_JO



B\_B\_



\_SPINACA

Nombre: .....

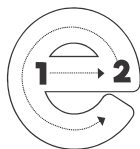
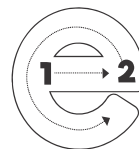
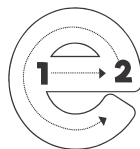
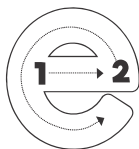
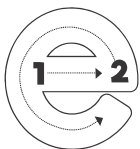
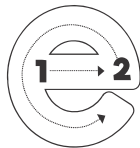
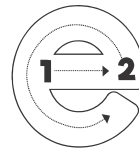
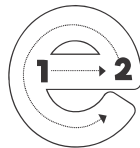
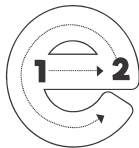
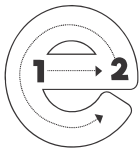
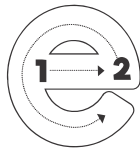
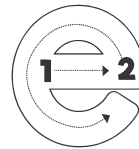
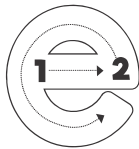
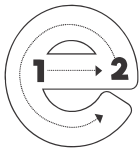
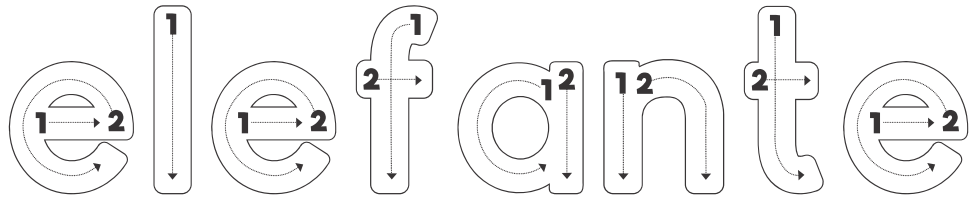
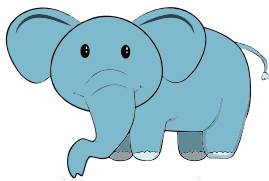
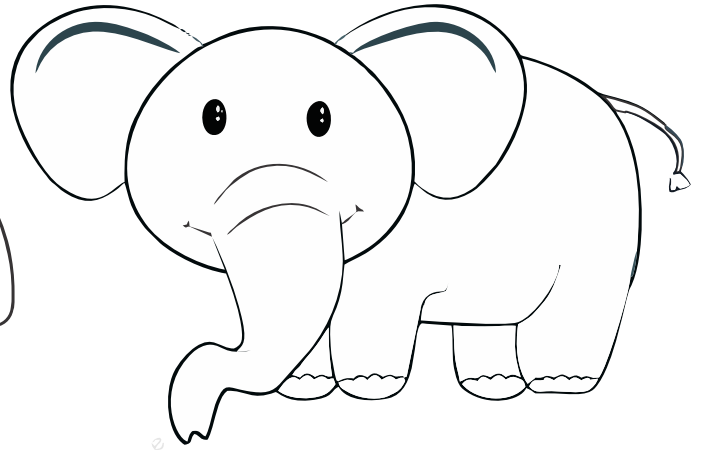
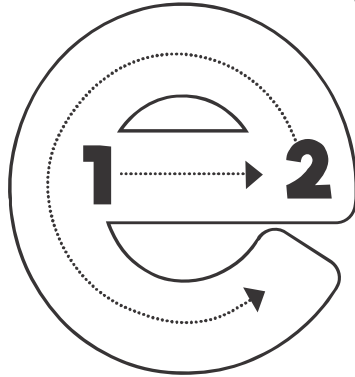
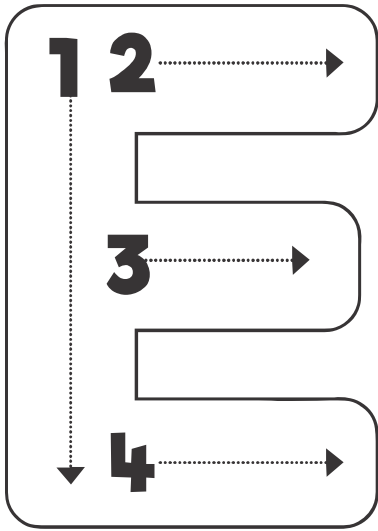

Nombre: .....

Trabajamos con la letra:

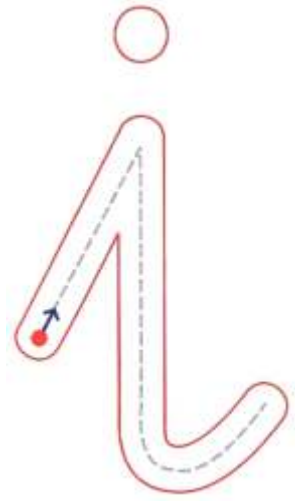

Colorea

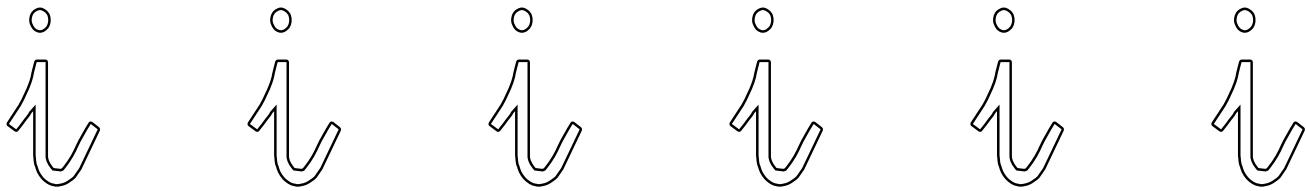

Repasa

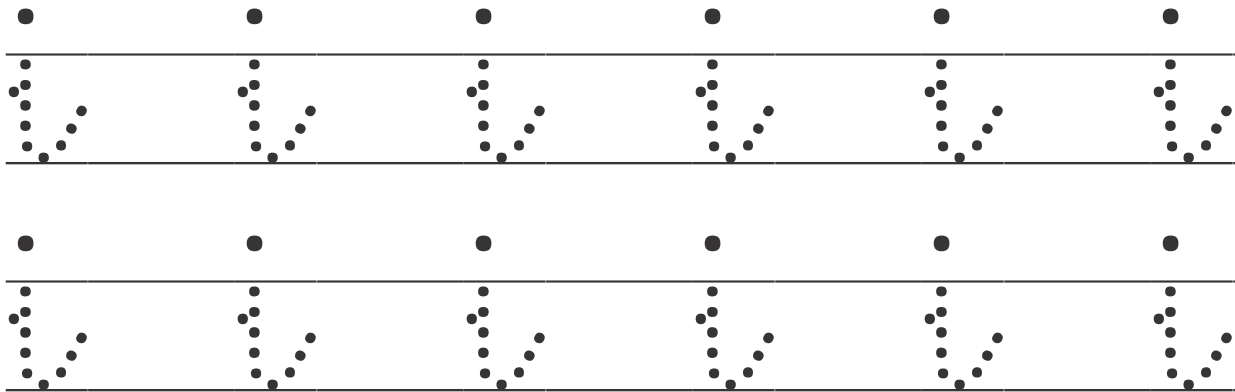

Escribe

Blank handwriting lines for independent practice, consisting of two rows of three horizontal lines each (top, middle, bottom).

Nombre: .....

LETRA MAYÚSCULA

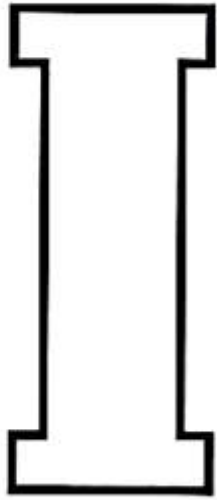

LETRA MINÚSCULA



Indio



Repasa las  
líneas  
punteadas

colorea



Nombre: \_\_\_\_\_

material gratuito

Trazar las letras:

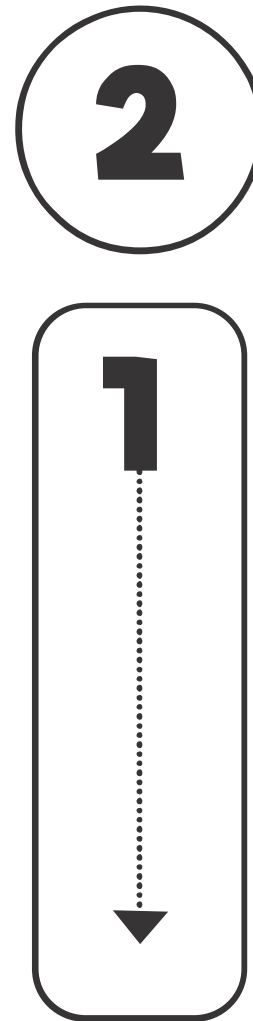
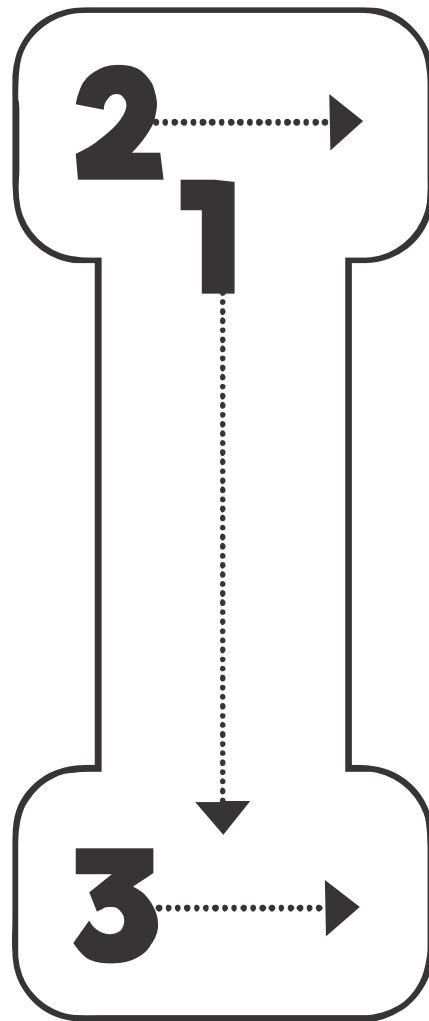



# PALABRAS QUE COMIENZAN CON...

EN CADA HILERA COLOREA LOS DIBUJOS CUYOS NOMBRES COMIENCEN CON LA VOCAL CORRESPONDIENTE.

A



E

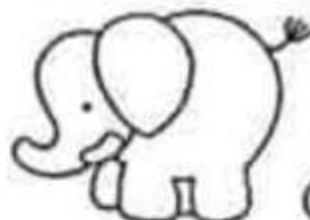

I

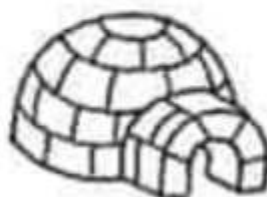
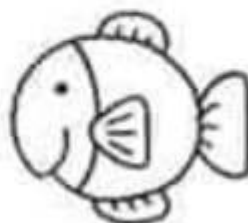

O



U

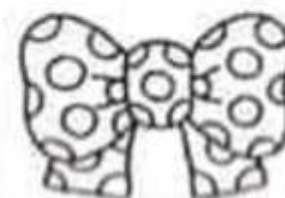
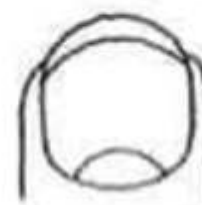
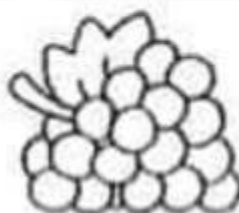
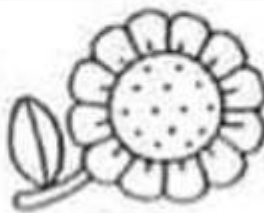

Nombre: .....

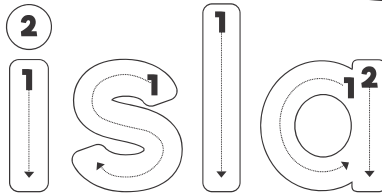
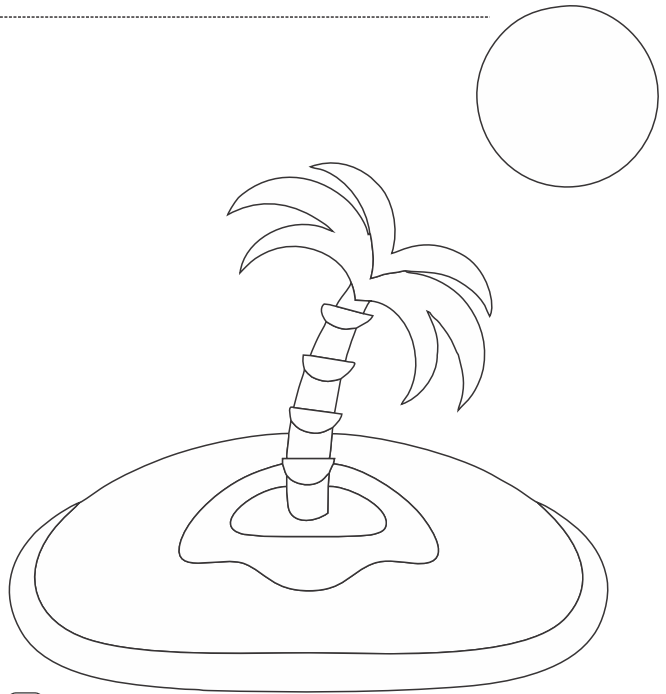
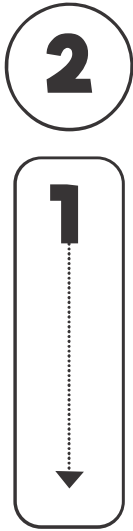
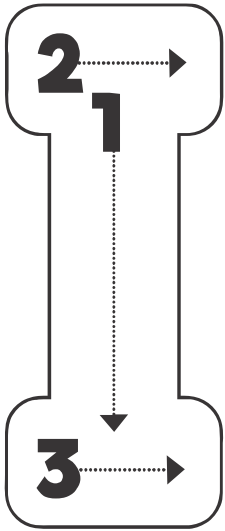

Nombre: .....

Trabajamos con la letra:

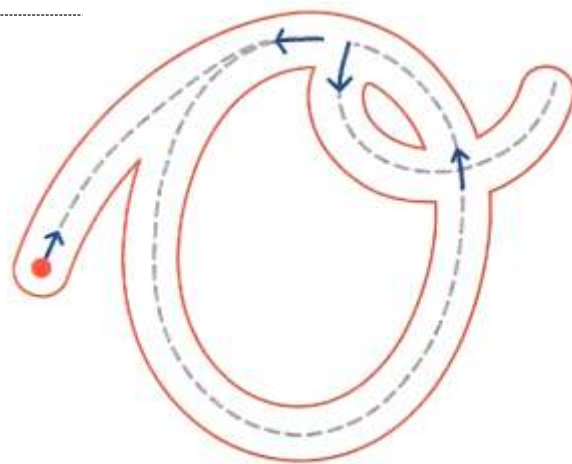

Colorea

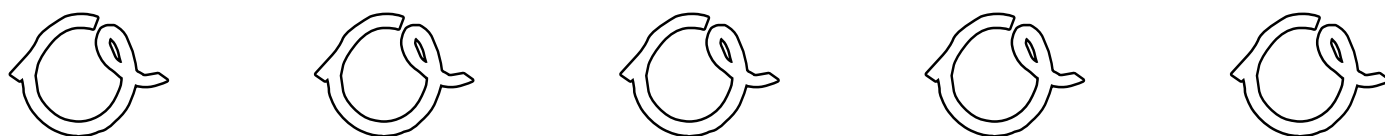

Repasa

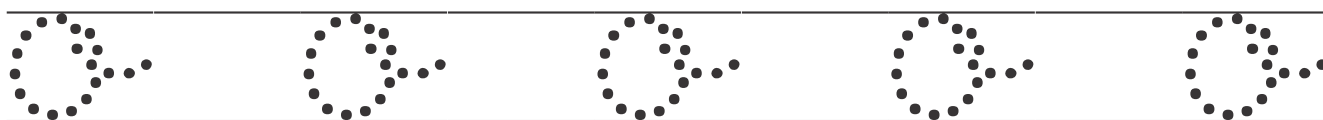

Escribe

Blank handwriting lines for independent practice, consisting of four sets of a solid top line, a dashed middle line, and a solid bottom line.

Nombre: .....

LETRA MAYÚSCULA

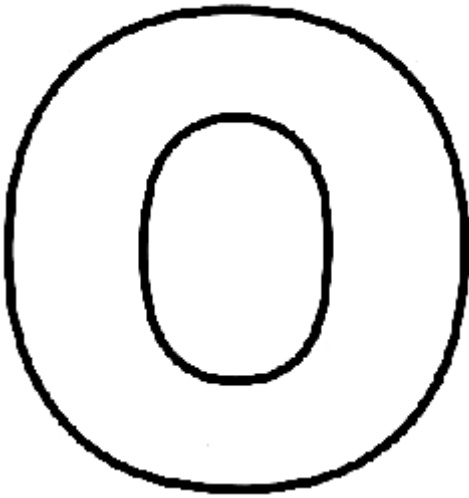

LETRA MINÚSCULA



Repasa las  
líneas  
punteadas



Oso

colorea



Nombre: \_\_\_\_\_

material gratuito

Trazar las letras:

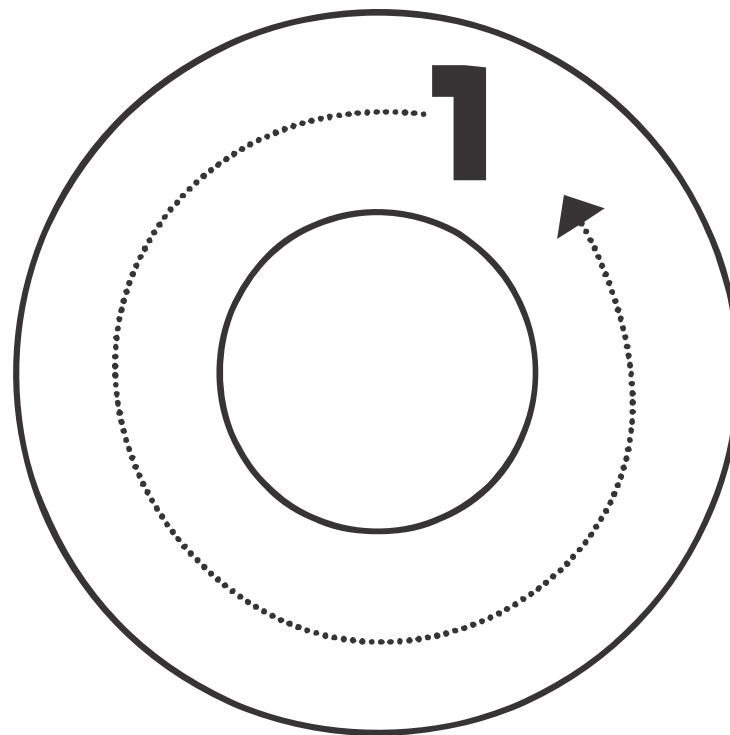
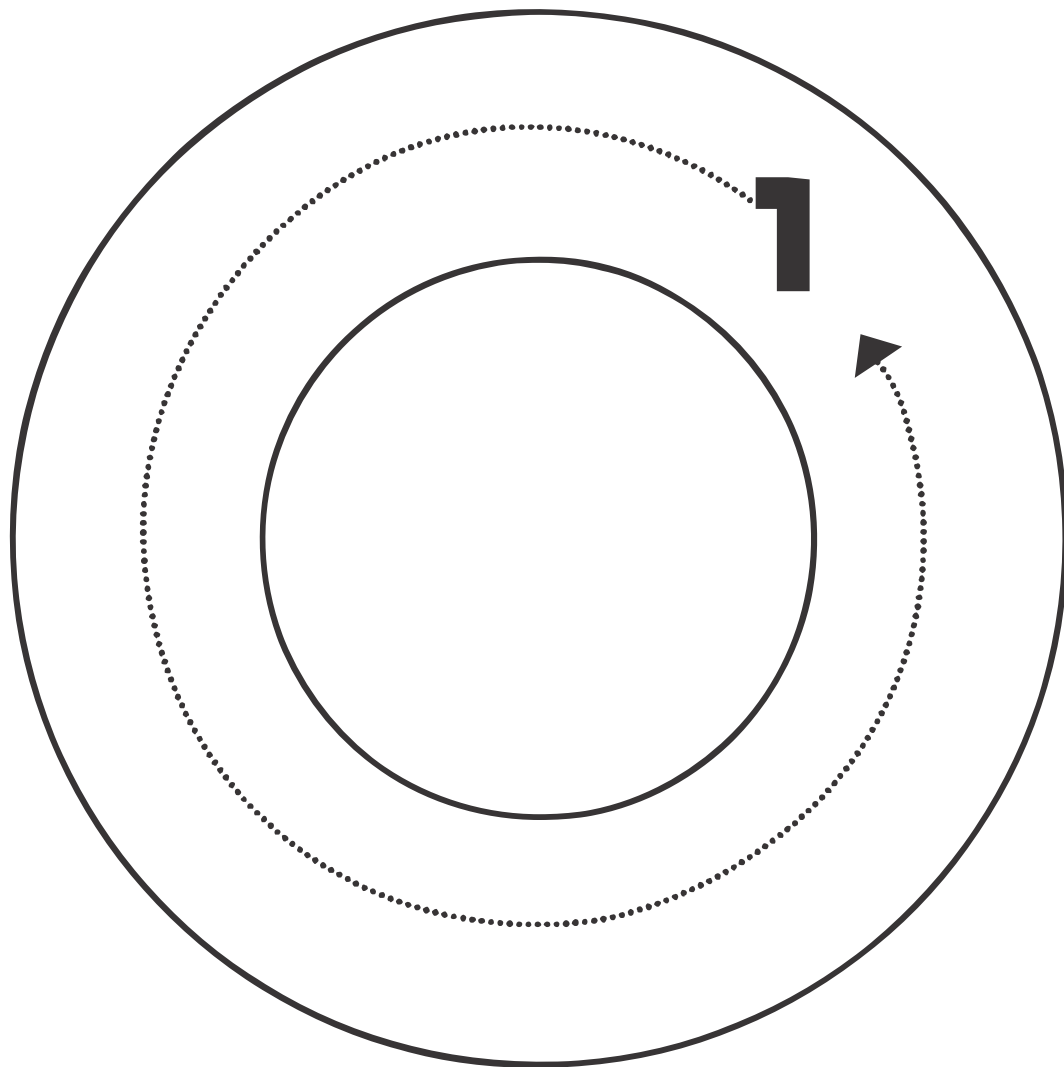



# LA LETRA O

COLOREA LA LETRA O. LUEGO COMPLETA CON ESTA LETRA LOS ESPACIOS EN BLANCO DE LAS PALABRAS.  
¿PUEDES LEER LAS PALABRAS QUE SE FORMARON?

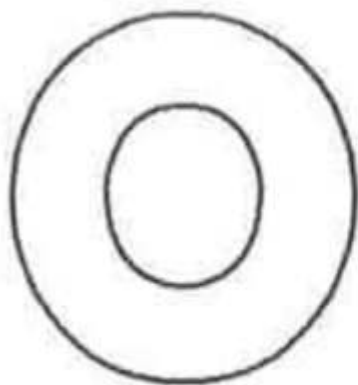

S \_ L



\_ S \_



ÁRB \_ L



Z \_ RR \_



G \_ RR \_



M \_ Ñ \_

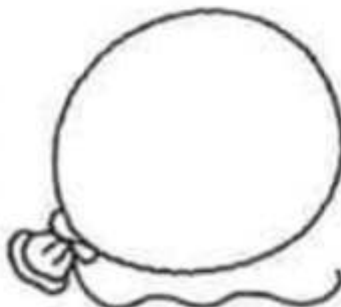

GL \_ B \_

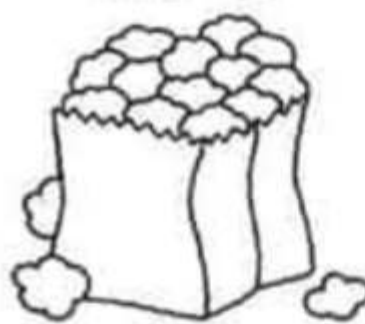

P \_ CH \_ CL \_



\_ LLA



M \_ N \_

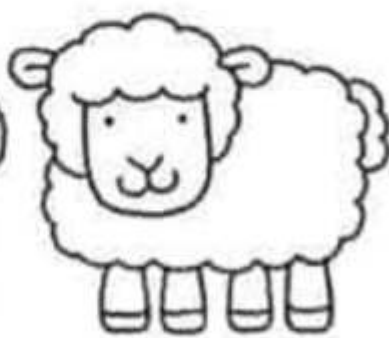

\_ VEJA



B \_ T \_ N



L \_ C \_ M \_ T \_ RA



TR \_ MP \_



Nombre: .....

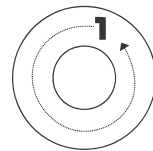
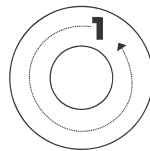
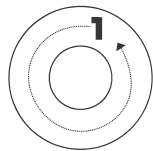
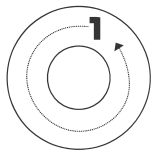
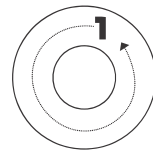
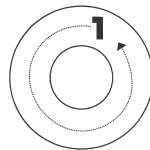
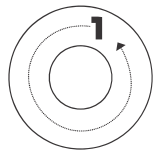
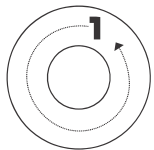
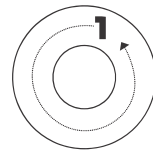
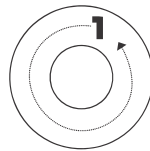
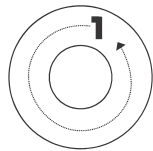
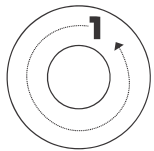
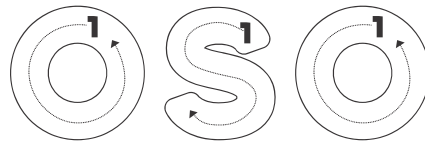
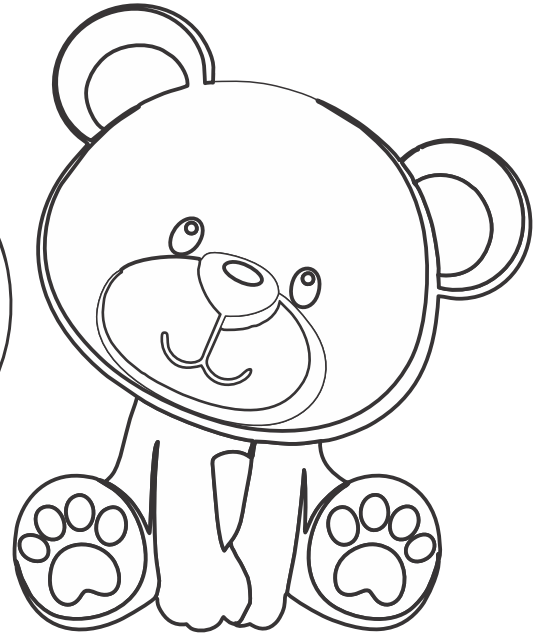
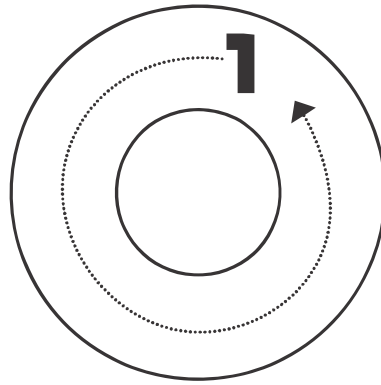
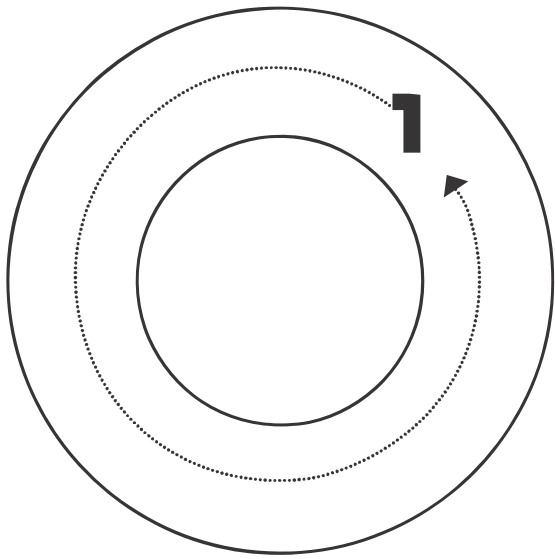

Nombre: .....

material gratuito

Trabajamos con la letra:

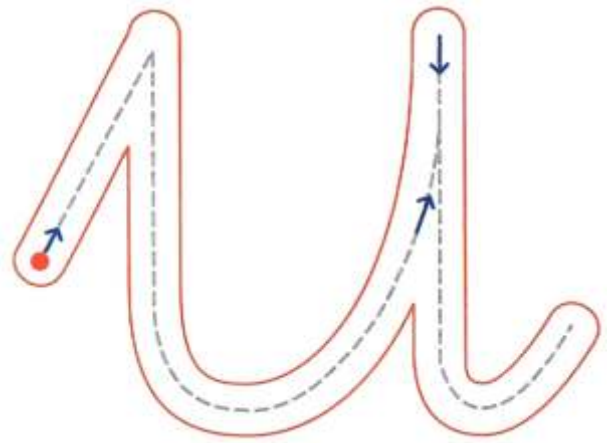

Colorea

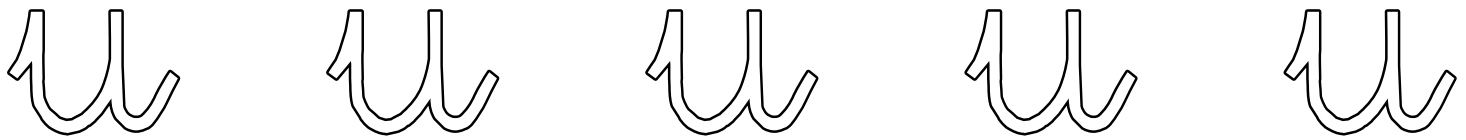

Repasa

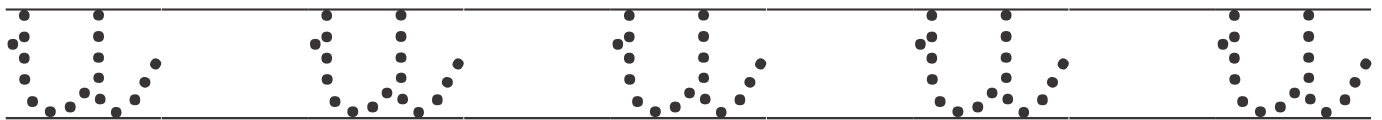
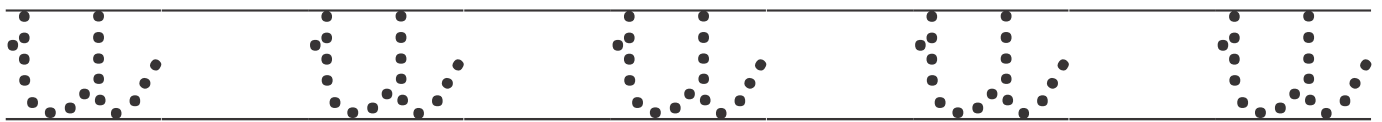

Escribe

Blank handwriting lines for independent practice, consisting of a solid top line, a dashed middle line, and a solid bottom line.

Nombre: .....

LETRA MAYÚSCULA

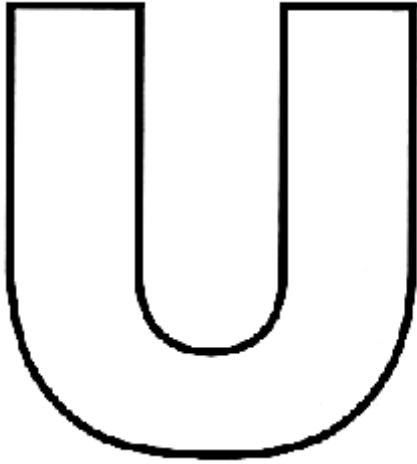

LETRA MINÚSCULA



Repasa las  
líneas  
punteadas

Unicornio



colorea



Nombre: \_\_\_\_\_

material gratuito

Trazar las letras:

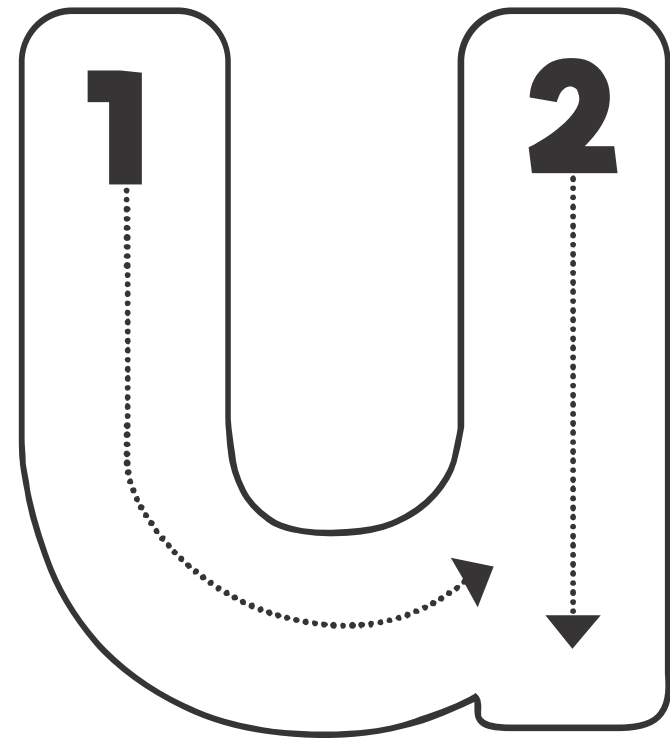
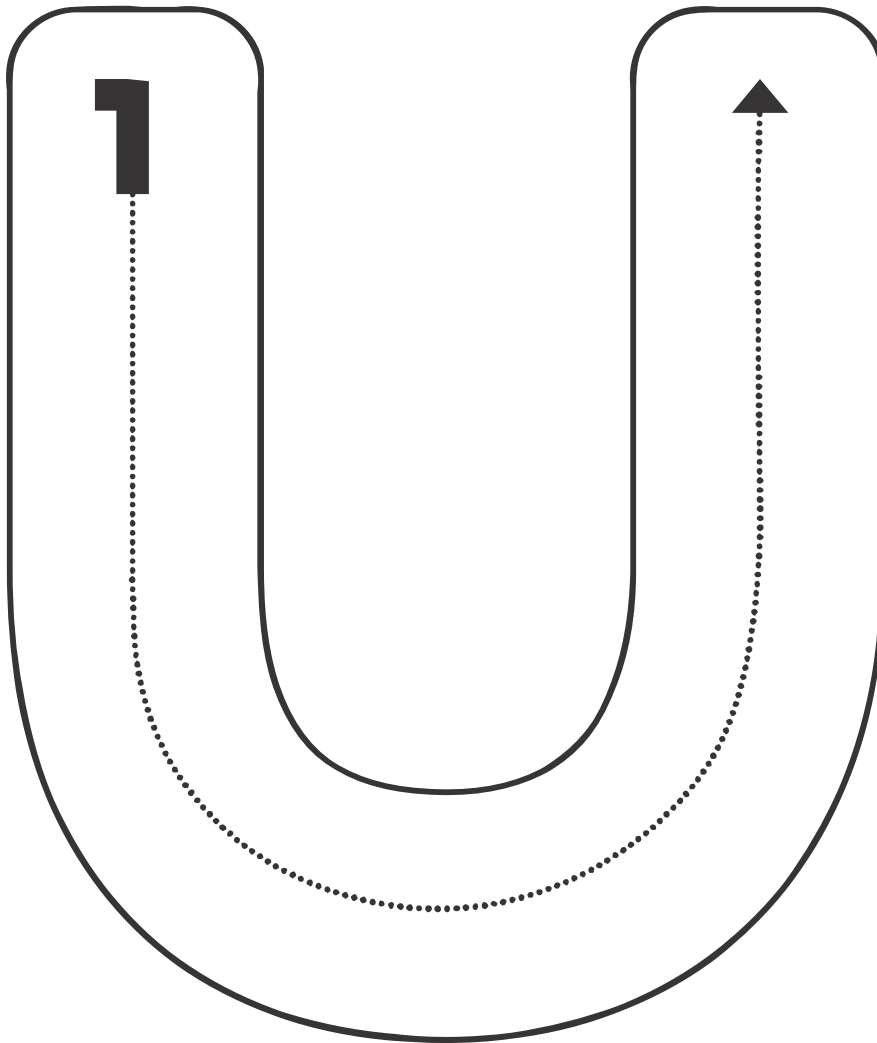

# LA LETRA U

COLOREA LA LETRA U. LUEGO COMPLETA CON ESTA LETRA LOS ESPACIOS EN BLANCO DE LAS PALABRAS.  
¿PUEDES LEER LAS PALABRAS QUE SE FORMARON?

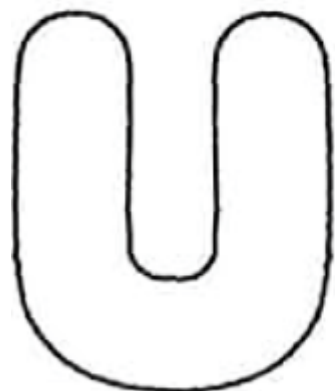

B \_ R B \_ J A S



\_ V A S



L \_ N A



P \_ L P O



N \_ M E R O S



J \_ G O



N \_ B E



N O

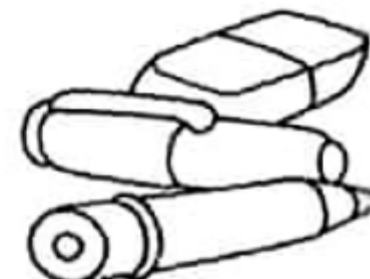

\_ T I L E S



F R \_ T A



C \_ C \_ R \_ C H O



\_ Ñ A



M \_ Ñ E C A



D \_ L C E

Nombre: .....

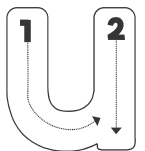
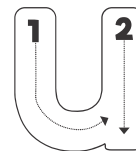
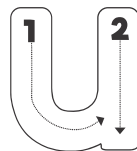
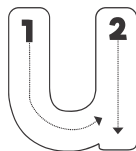
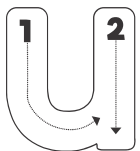
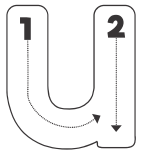
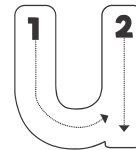
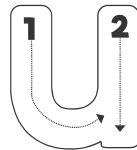
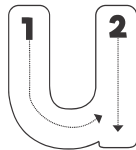
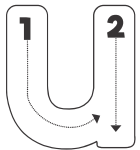
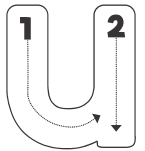
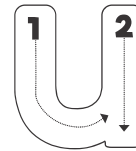
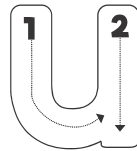
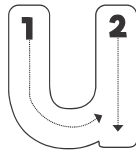
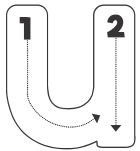
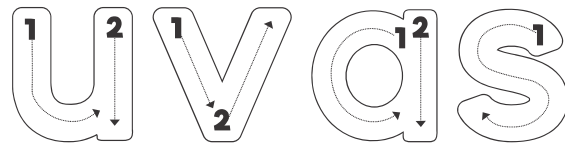
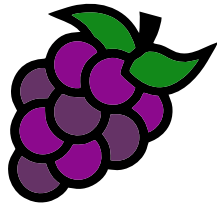
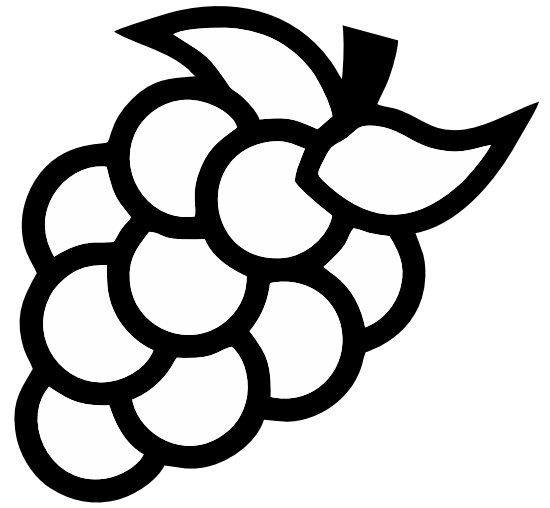
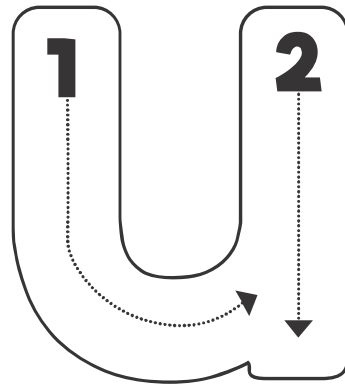
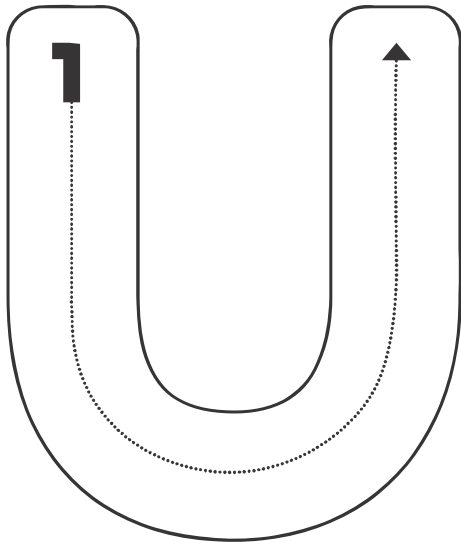



Nombre: .....

# REPASA Y COLOREA

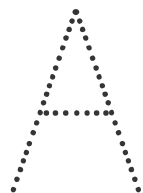
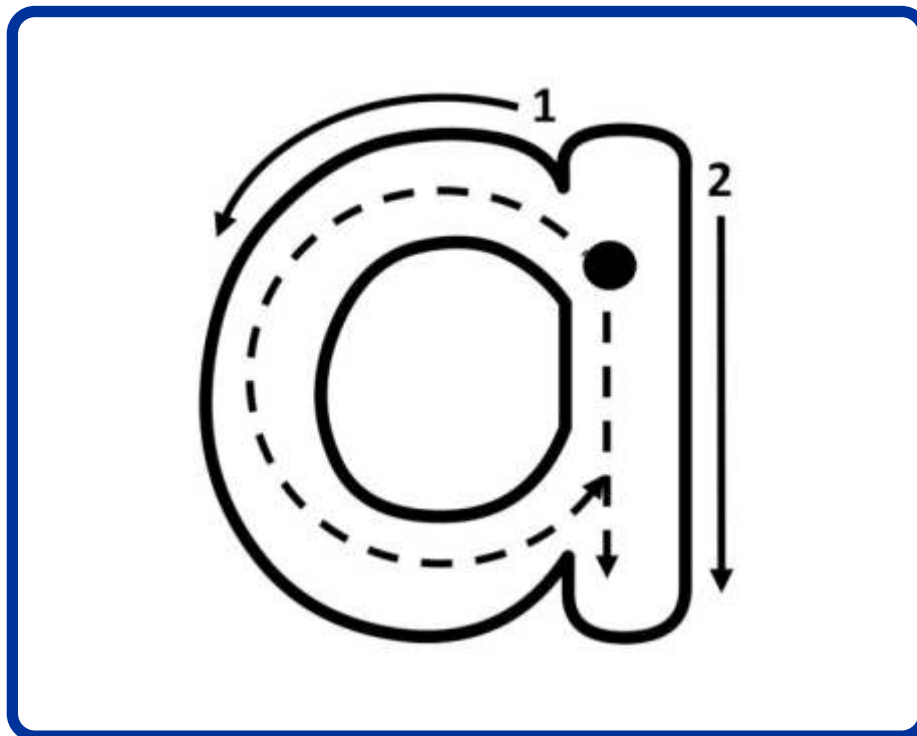
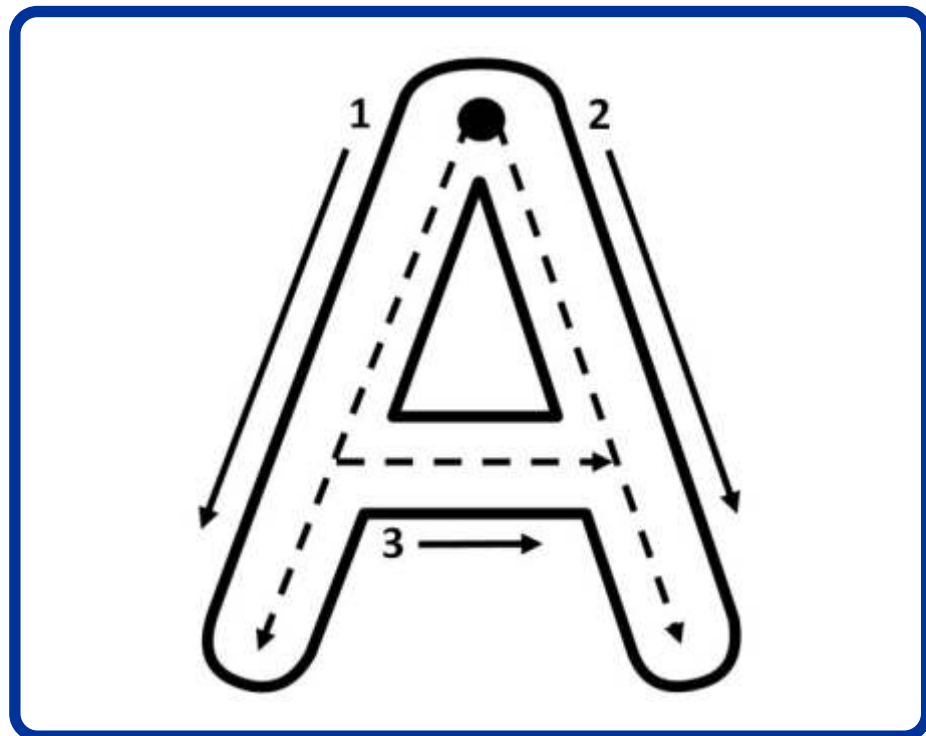

Nombre: .....

# REPASA Y COLOREA

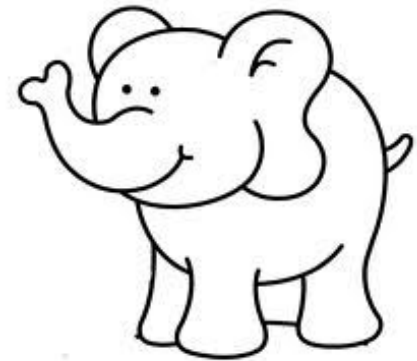
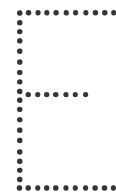
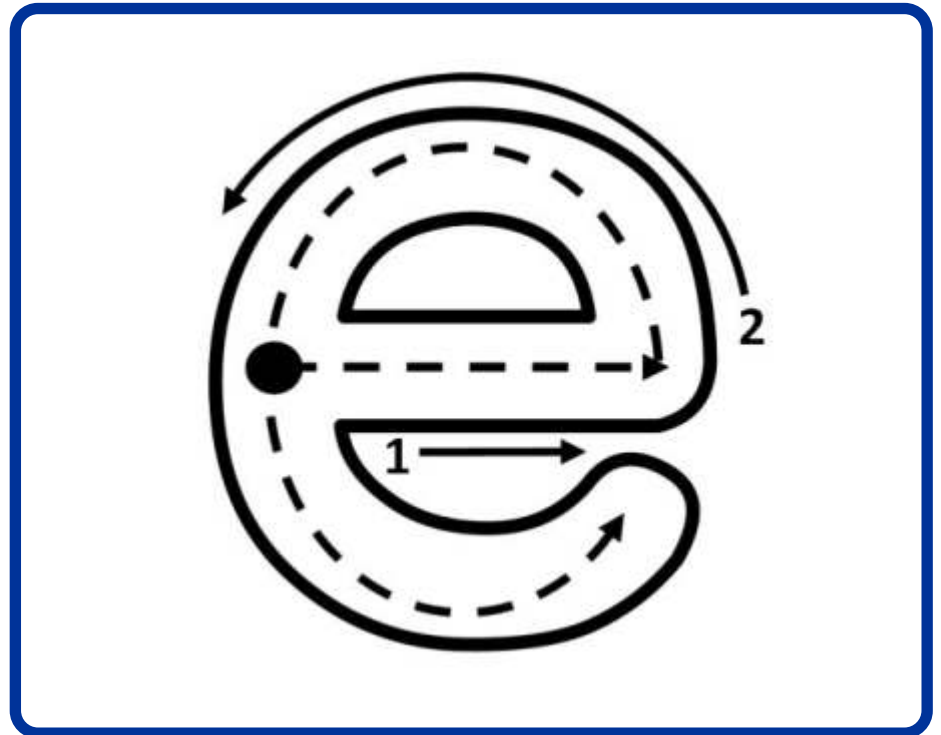
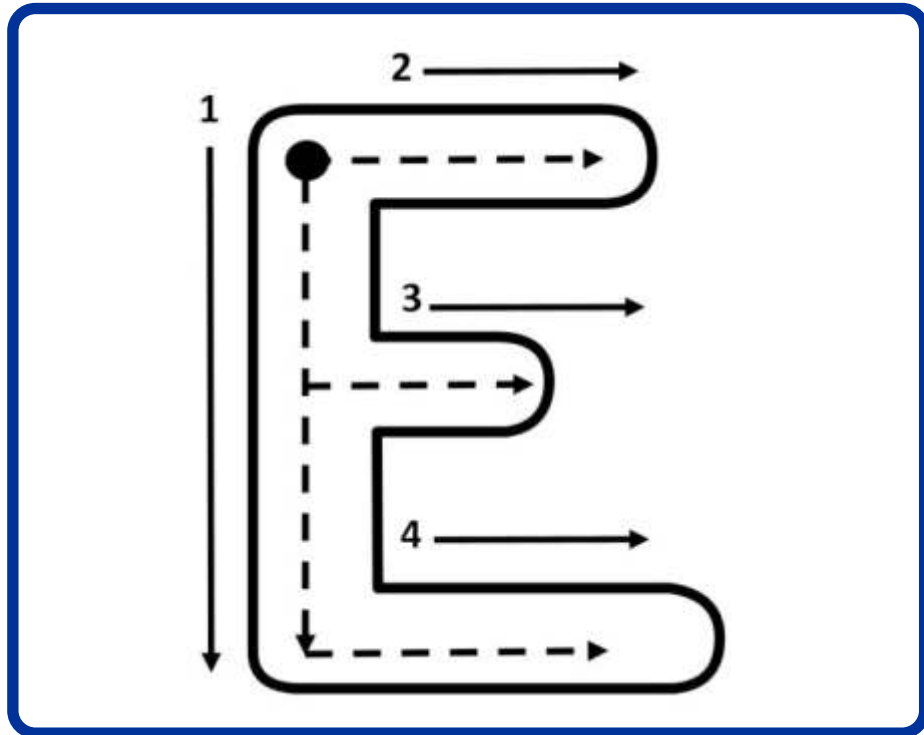

Nombre: .....

# REPASA Y COLOREA

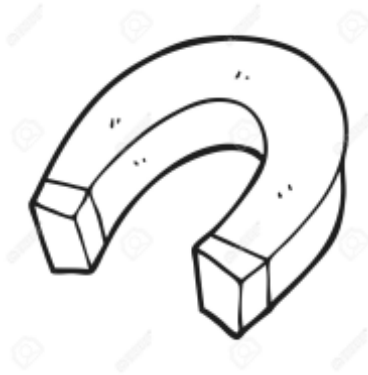
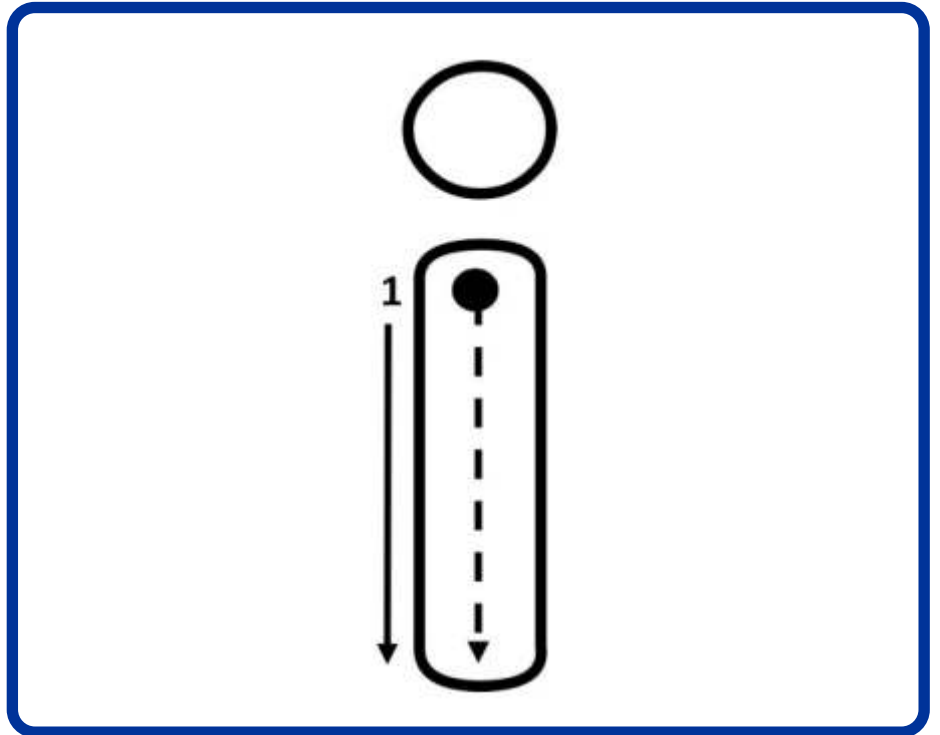
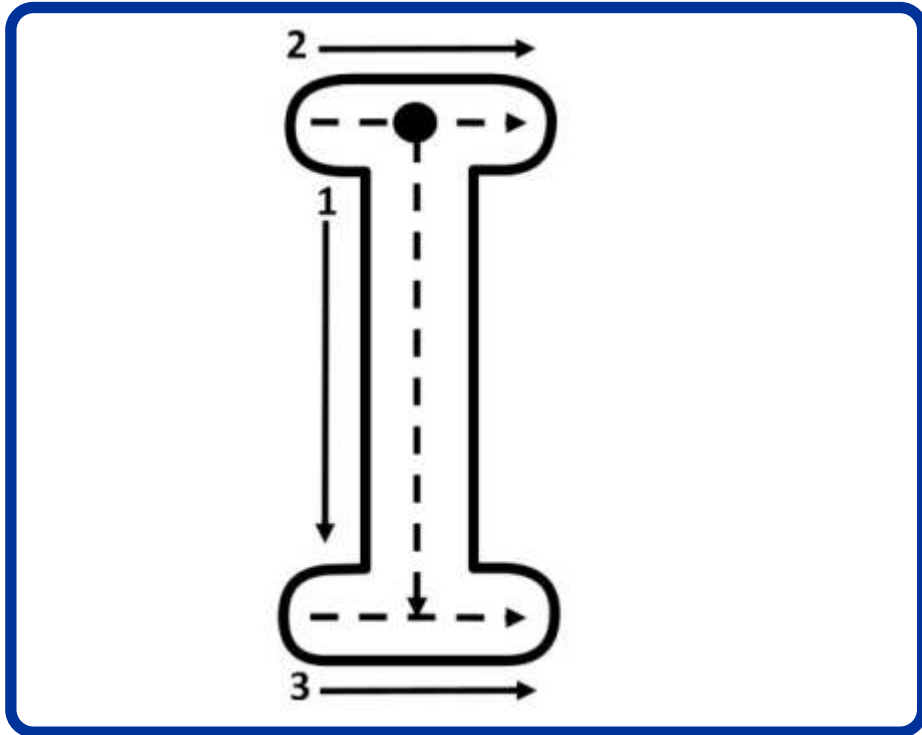

Nombre: .....

# REPASA Y COLOREA

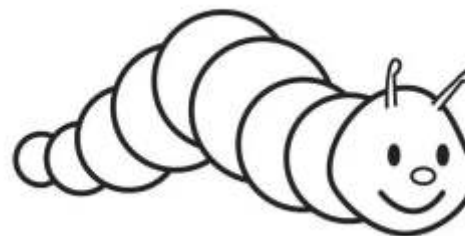
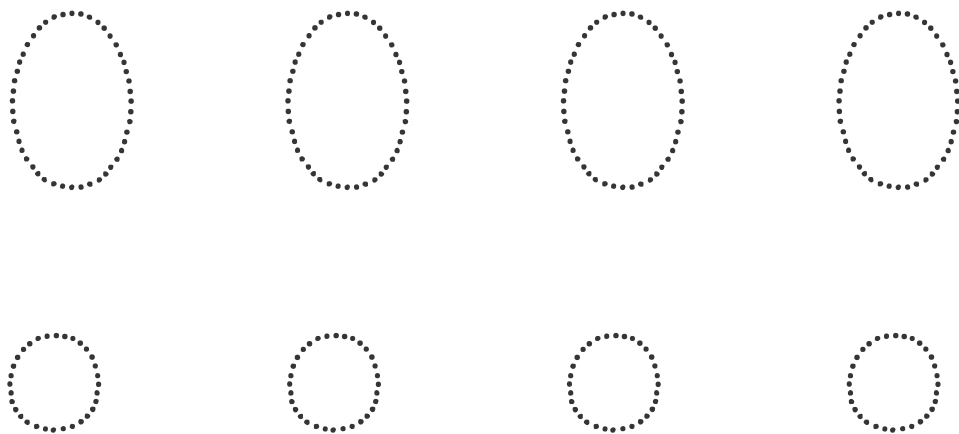
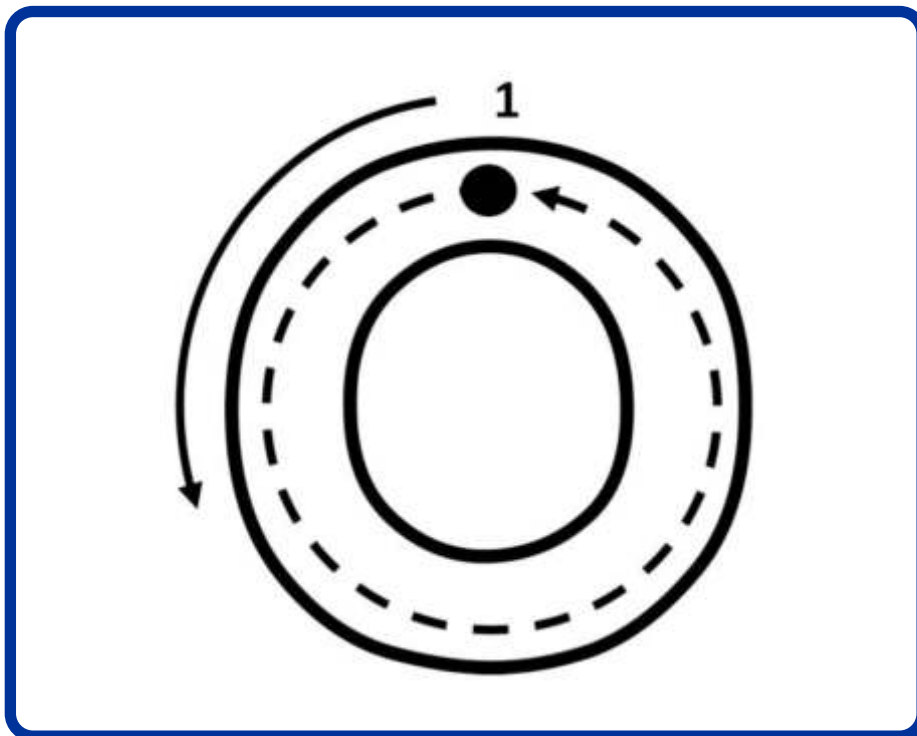
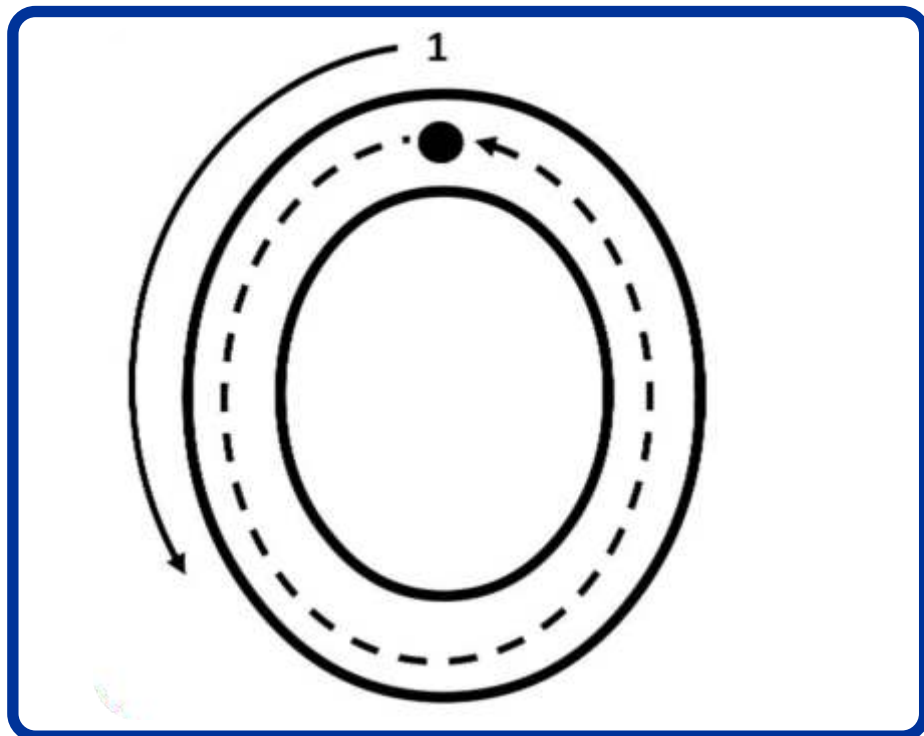

Nombre: .....

# REPASA Y COLOREA

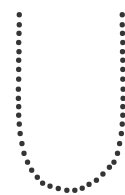
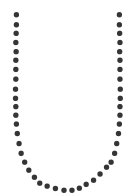
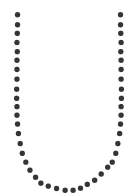
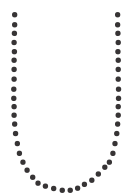
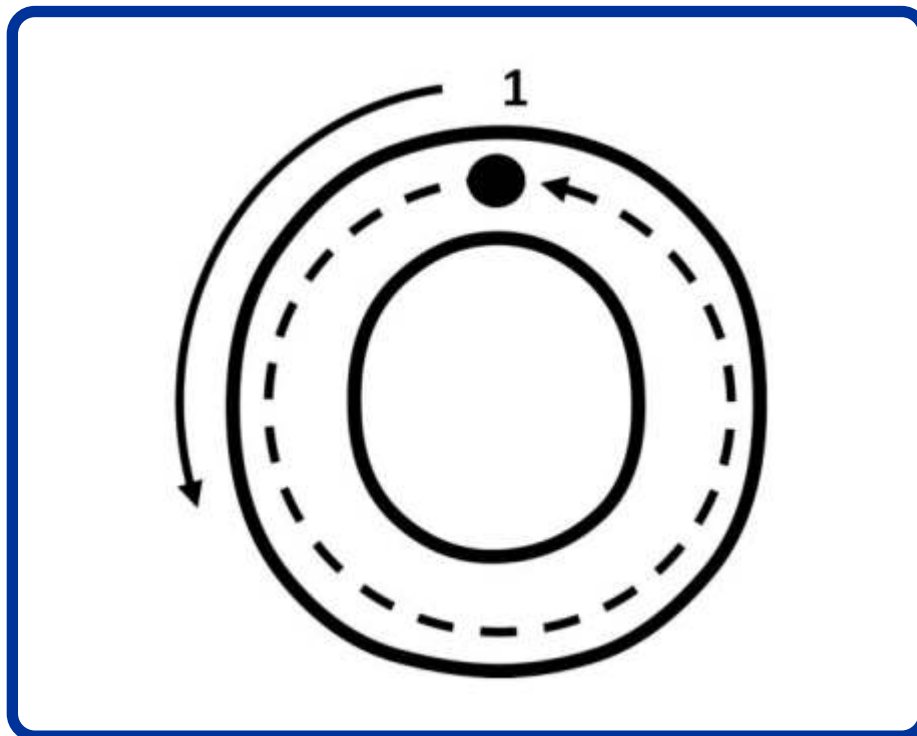
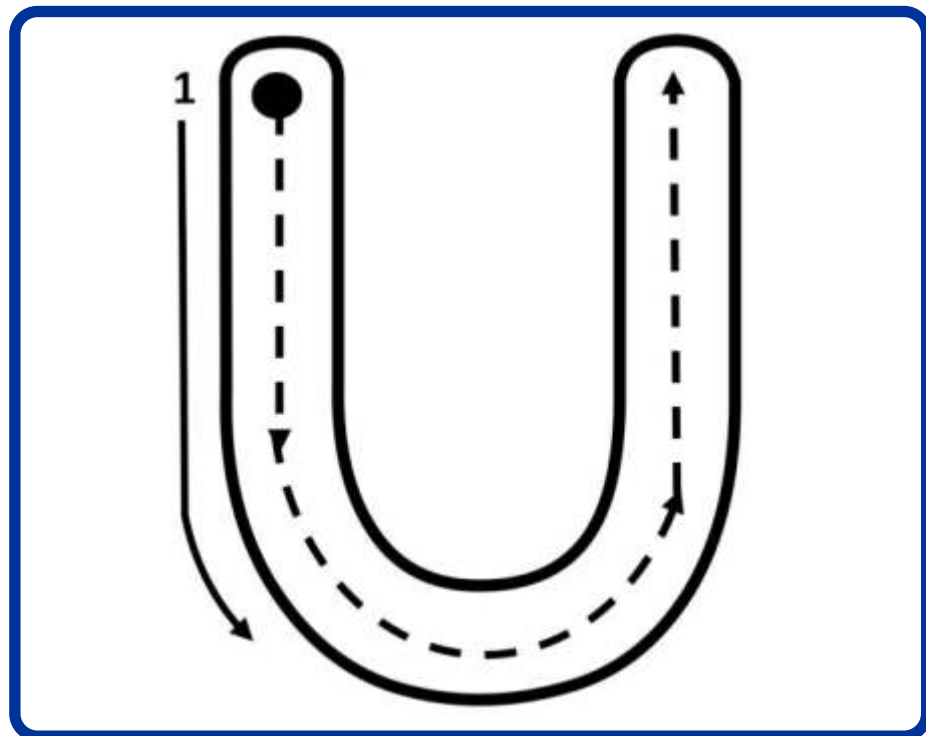

Nombre: .....

material gratuito

Une cada dibujo con su vocal inicial



•

• a



•

• e

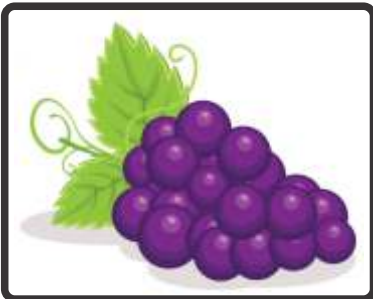

•

• i



•

• o



•

• u



# LAS VOCALES

material gratuito

 Escribe las vocales que llevan los nombres de los dibujos :



— — —



— — —

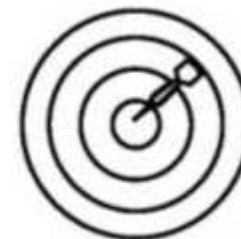

— — —

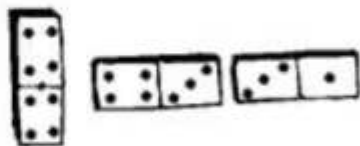

— — —

— — —



— — —



7

— — —



— — —

# LAS VOCALES

material gratuito

 Escribe las vocales que llevan los nombres de los dibujos :



— — —



— — —



— — —

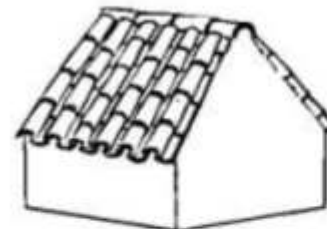

— — —



— — —



— — —



— — —

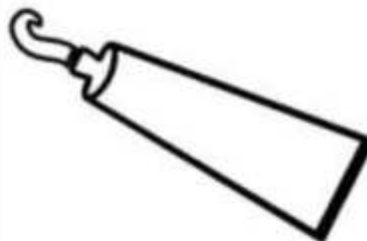

— — —



— — —



— — —



— — —



— — —



— — —



— — —



— — —

# LAS VOCALES

material gratuito

 Une cada dibujo con las vocales que tenga su nombre.

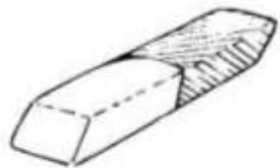

o a



e a



i o



i a



e a



a e



a i



o a

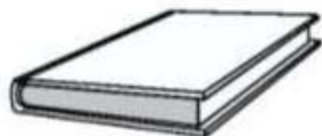

e o



a a



PAGINA WEB:

[www.manualidadeseducativas.com](http://www.manualidadeseducativas.com)

FACEBOOK:



[MEmanualidadeseducativas](https://www.facebook.com/MEmanualidadeseducativas)

## MATERIAL GRATUITO

Si vas a compartir nuestro material  
en tu página y/o blog, poner crédito y fuente.

[www.manualidadeseducativas.com](http://www.manualidadeseducativas.com)